



Contents:
Identification p02
Fully Sealed Calipers p09

BPW p10
DAF p13
Iveco p15
Jost p18
MAN p21
Mercedes p26
Renault p36
ROR p40
SAE-SMB p42
SAF p44
Scania p48
Schmitz p54
Volvo p57
ZF p61

Kits p64
Full Assemblies p66
Carriers p68



REGISTER

Please ensure that you register your caliper with MEI on installation. The two-year warranty will then commence from the date you registered your caliper. If the calipers are not registered then the 2 year warranty date will commence from the production date of the caliper.

You can register your caliper here:

<https://www.meibrakes.com/register-your-caliper.html>

Terms and Conditions are available on request or can be found on the MEI website

IDENTIFICATION - L SERIES CALIPERS (KNORR)

MEI Air Disc Brake Calipers are identified by the part number which is marked on the ID plate. After a long life in service or while still on the vehicle it can be difficult to read the information on the ID plate. Therefore the following can be useful in assisting identification.



Mounting Angle

First, check the air chamber mounting angle. This ranges from -12° to $+8^{\circ}$.

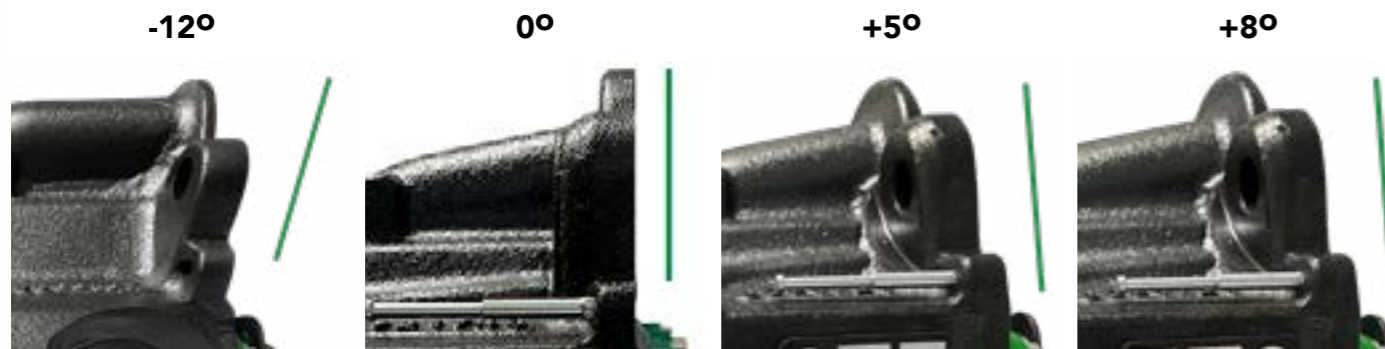

For radial calipers (LNR225) the mounting angle ranges from $+86^{\circ}$ to $+93^{\circ}$.



Guide Sleeve

Next, check if the Long Guide Sleeve is on the Left or Right as shown.



Size

Confirm the brake size. If there are bolts visible as shown in picture 1 (see below), attaching the cover plate to the housing, the brake is either LB195, LC225 or LA225.

- Measure the caliper at its widest point. If the caliper is 350mm diameter it is an LB195 brake.
- If the caliper is 375mm diameter it is either an LC225 or an LA225 brake. You can either:
 - Measure the diameter of the steel tappet head as shown in picture 2 (below). If the tappet head is 65mm wide it is an LC225. If it is 58mm wide it is an LA225.
 - Measure the distance between the guide sleeves as shown in picture 3 below. If the distance is 278mm it is an LA225. If it is 266mm it is an LC225.



If there are no bolts visible it is an LB225, LV225 or LNR225 brake. The mounting angle of the LNR brake (see earlier) makes it easy to identify. To distinguish between the LB225 and the LV225:

- Measure the diameter of the steel tappet head as shown in picture 2 above. If the tappet head is 65mm wide it is an LB225. If it is 58mm wide it is an LV225.

Tip: To distinguish between the LC225 and the LA225, or the LB225 and LV225, examine the steel tappet heads. Notice how the tappet heads are more prominent on the LC225 / LB225 (left) than on the LA225 / LV225 (right).



There are two other measurements that can help to identify the caliper.

The rotor diameter will be 377mm for LB195 brakes. For all other brakes it will be 430mm.

The pad width is 248mm for LNR225 and LB225 brakes. It is 245mm for LV225 brakes, 208mm for LA225 brakes and 211mm for LC225 and LB195 brakes.

Fitment Type

Check the pad wear sensor cable fitment type on the chain cover - it can be without sensor (left) or with sensor (right).



The pad wear sensor types are shown below:



If you have determined the type of caliper, the position of the long guide sleeve, the mounting angle and the fitment type then you should be able to identify the MEI part number. The next two pages will help with this process.

IDENTIFICATION - QUICK GUIDE (KNORR CALIPERS)

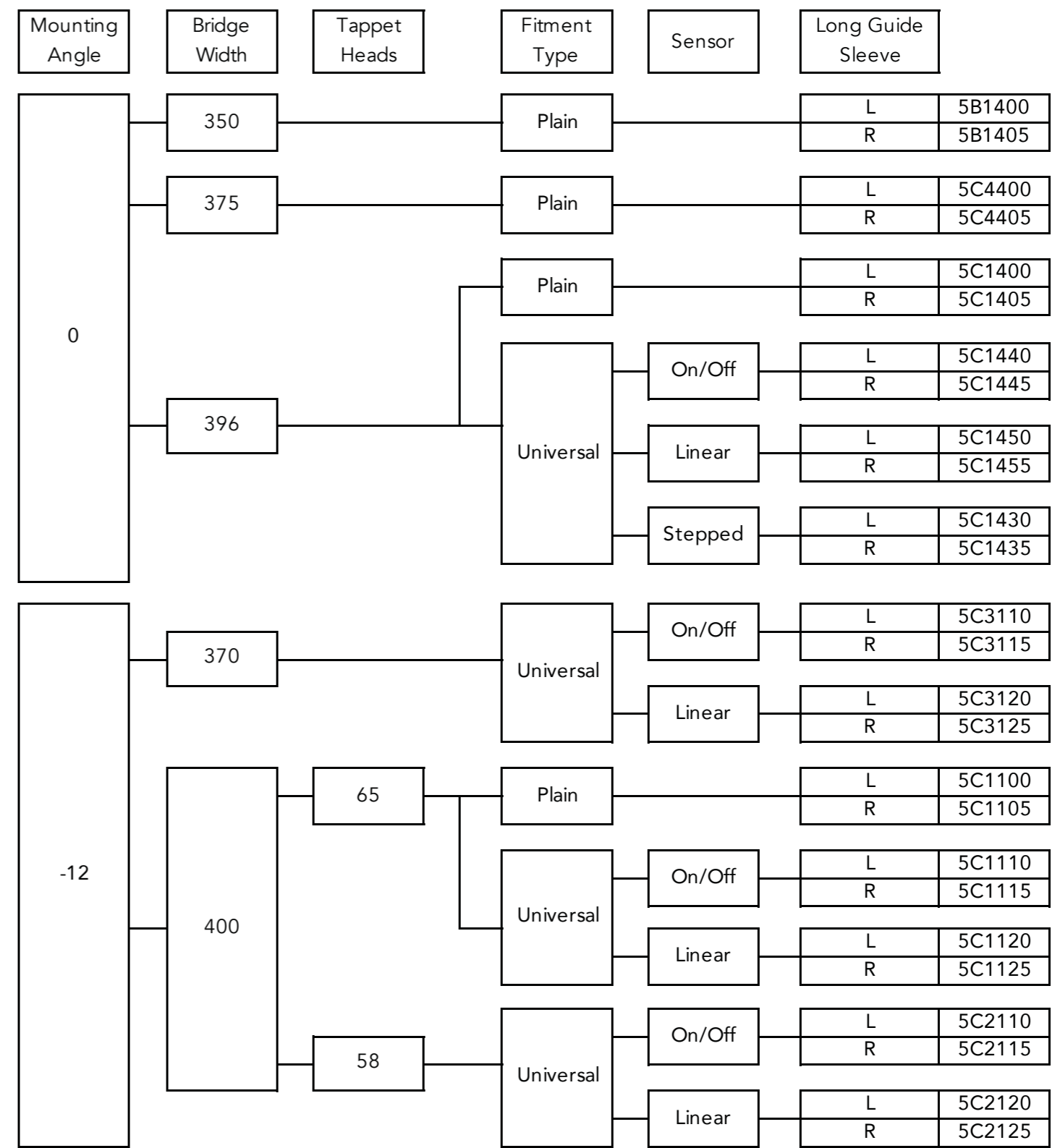
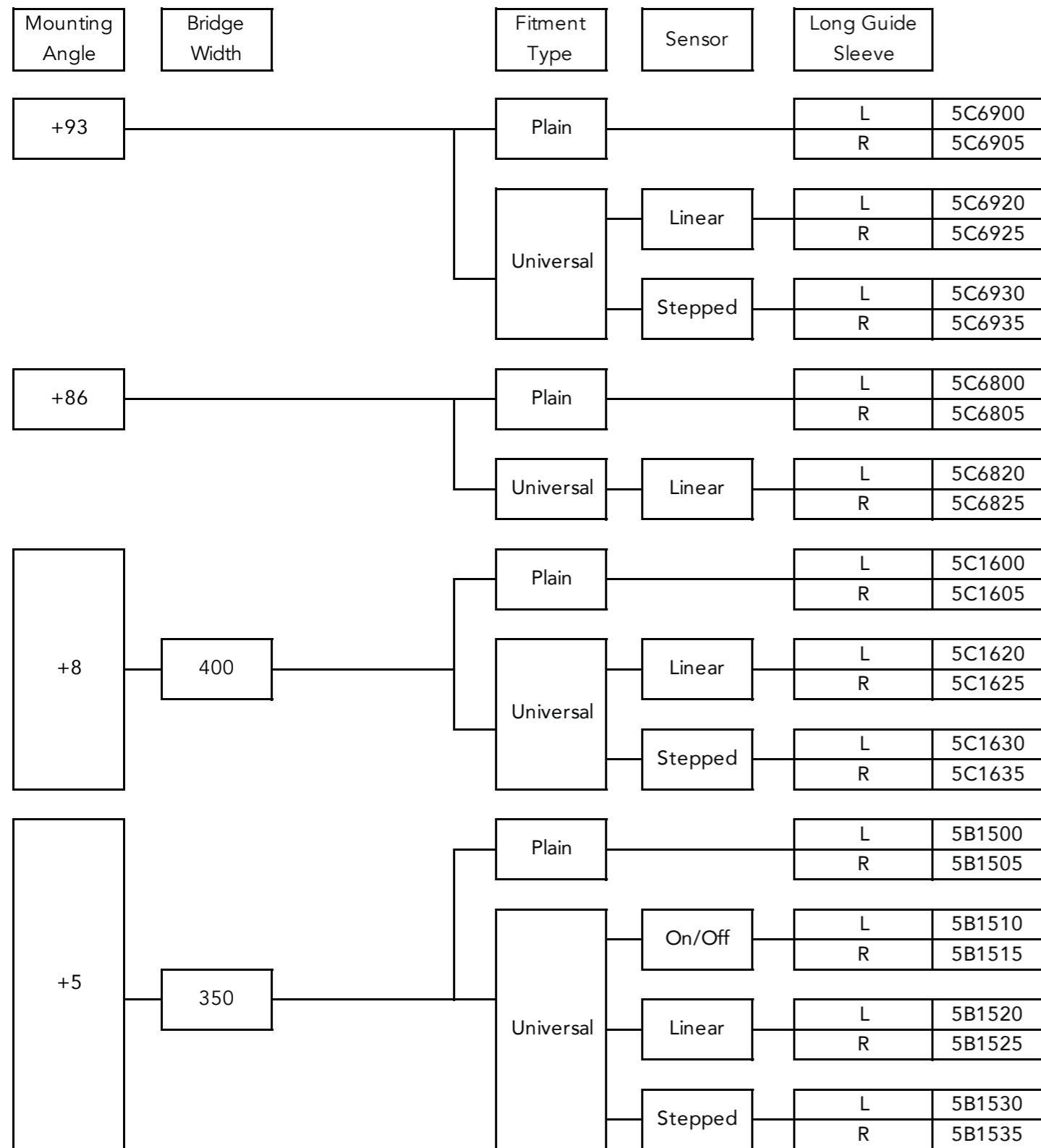

IDENTIFICATION - N SERIES CALIPERS (MERITOR)

MEI Air Disc Brake Calipers are identified by the part number which is marked on the ID plate. After a long life in service or while still on the vehicle it can be difficult to read the information on the ID plate. Therefore the following can be useful in assisting identification.



Mounting Angle

Check the air chamber mounting angle. This can either be +81 (NR225) or 0 degrees.

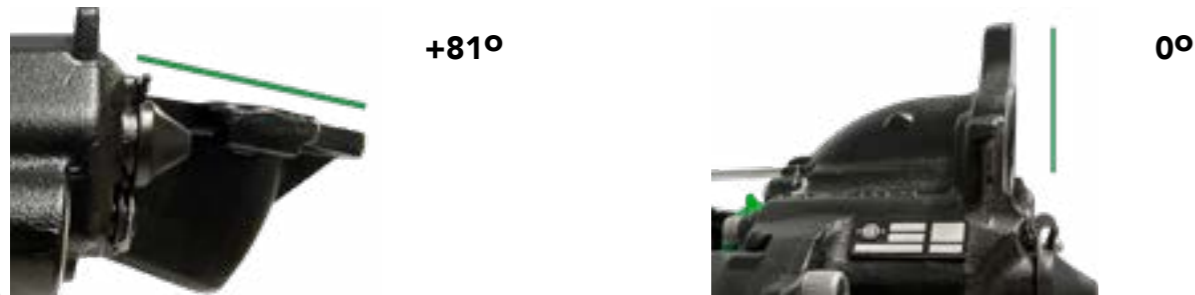

Size

Measure the distance between the centre of the guide sleeves. It will either be 305mm (NR225 or NT225) or 264mm (NV225, NX225, NV195 & NX195).

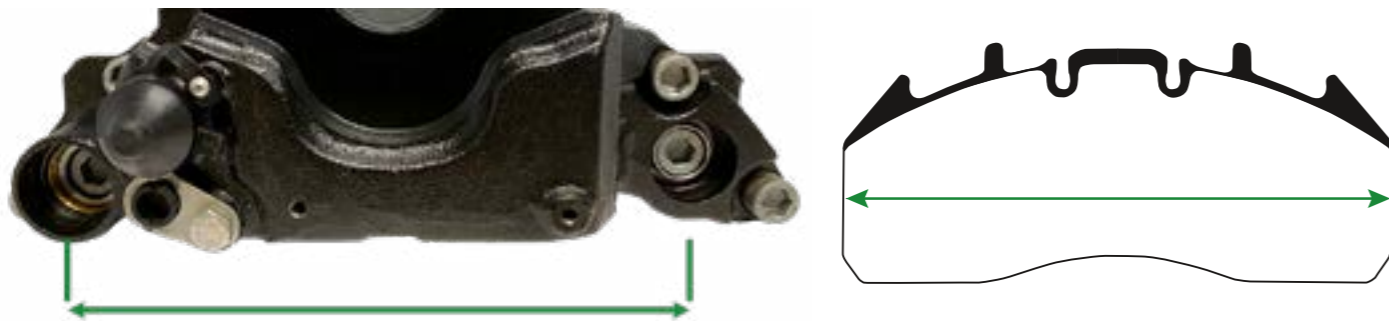

Measure the width of the pads. They will be either 250mm wide (NR225 or NT225), 216mm wide (NV225 or NX225) or 210mm wide (NV195 or NX195).

Carrier Mount

Check the carrier - there will be 6 x M20 bolts (NR225, NT225, NV225 & NV195 or 4 x M18 bolts (NX225 & NX195).

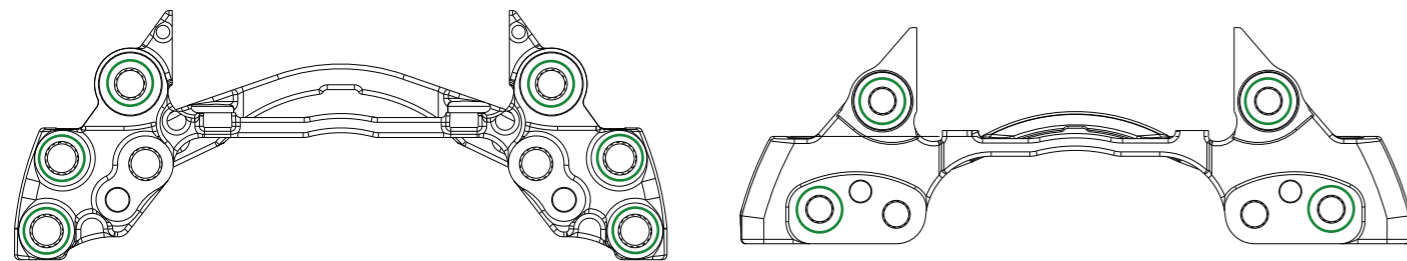

Guide Sleeve

Finally, check if the Long Guide Sleeve is on the Left or Right as shown.



Identification Guide

Once you have identified the mounting angle etc. you should be in a position to identify the caliper part number. The table below will help with this process.

Mounting Angle	Guide Sleeve Centre	Pad Width	Carrier Bolts	Fixed Guide Sleeve	Part Number	Type
+81	305mm	250mm	6 x M20	L	9C4200-74	NR225
				R	9C4205-74	
0	264mm	210mm	6 x M20	L	9B2100-71	NV195
				R	9B2105-71	
		216mm	4 x M18	L	9B1100-70	NX195
				R	9B1105-70	
	305mm	216mm	6 x M20	L	9C2100-73	NV225
				R	9C2105-73	
		210mm	4 x M18	L	9C1100-72	NX225
				R	9C1105-72	
250mm	6 x M20	L	9C3100-74	NT225		
		R	9C3105-74			

TYPICAL INSTALLATION POSITIONS

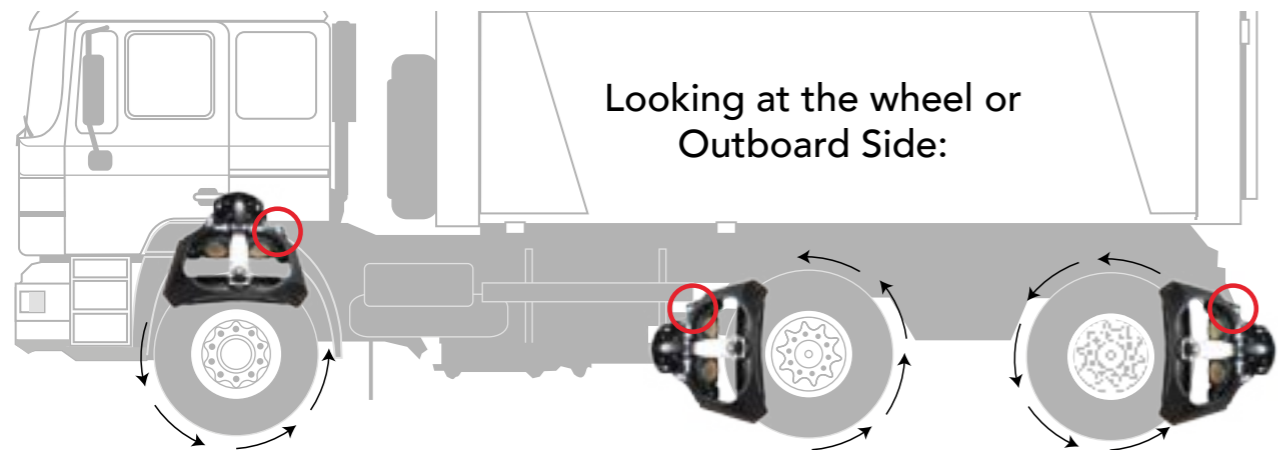

Looking at the wheel or Outboard Side:

12 o'clock Mount
Long Guide Sleeve
Leading

9 o'clock Mount
Long Guide Sleeve
Leading

3 o'clock Mount
Long Guide Sleeve
Trailing



Long Guide Sleeve
on the Left



Long Guide Sleeve
on the Left



Long Guide Sleeve
on the Right

If the brake is fitted at 12 o'clock the long guide sleeve is leading.

If the brake is fitted to the front or rear of the axle (3 o'clock or 9 o'clock) then it normally hangs from the long pin:
- if in front (9 o'clock) the long pin is leading
- if at the back (3 o'clock) the short pin is leading

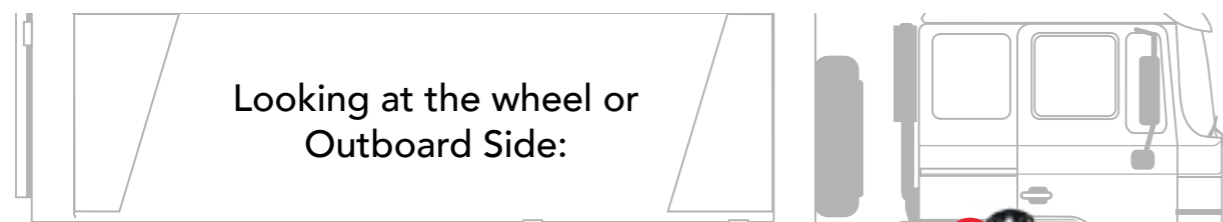

Looking at the wheel or Outboard Side:

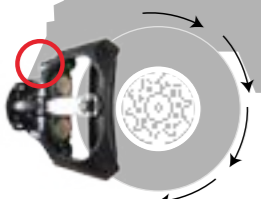

9 o'clock Mount
Long Guide Sleeve
Trailing

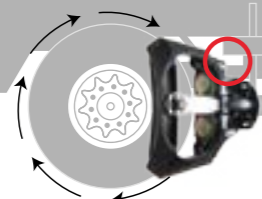

3 o'clock Mount
Long Guide Sleeve
Leading

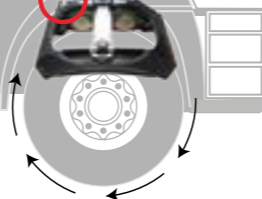

12 o'clock Mount
Long Guide Sleeve
Leading



Long Guide Sleeve
on the Left



Long Guide Sleeve
on the Right



Long Guide Sleeve
on the Right

If the brake is fitted to the front or rear of the axle (3 o'clock or 9 o'clock) then it normally hangs from the long pin:
- if in front (3 o'clock) the long pin is leading
- if at the back (9 o'clock) the short pin is leading

If the brake is fitted at 12 o'clock the long guide sleeve is leading.

FULLY SEALED CALIPERS

Water and dirt ingress have long been issues for brake calipers causing sliding problems on most applications.

Symptoms include:

- Hot Brakes, Excessive Outboard Pad Wear & Brake Rotor Wear, Leading to:
- Fleet Downtime, Higher Lifetime Caliper Costs & Increased Fleet Costs

MEI have patented the solution to these issues and all calipers are now produced with fully sealed stainless steel guide sleeve bushes.

- Tested in the Field
- MEI Patented System
- Fully Sealed Short Guide Pin
- Stainless Steel Outer Bush
- MEI Click & Seal Boot Cap
- Unique Design for MEI Calipers
- Sealed Boot to Protect the Exposed Guide Pin



5B1500

LB195

BPW 0536270371

K013173

K132664X50



Brake Chamber Mounting Angle
+5°



Long Guide Sleeve



Chain Cover - Plain



5C1400

LB225

BPW 0536270380

K003783

K153782X50



Brake Chamber Mounting Angle
0°



Long Guide Sleeve



Chain Cover - Plain



Guide Sleeve Kits - Fully Sealed 5B1500 / 05

5R0215 - Full Kit 5RS215 - Single Sleeve



Guide Sleeve and Tappit Boot Kits To Fit All 5B1500 / 5B1505 Calipers

5R0400 - Tappet Kit 5R0200 - Full Kit 5RS200 - Single Sleeve



Guide Sleeve Kits - Fully Sealed 5C1400 / 05

5R0215 - Full Kit 5RS215 - Single Sleeve



Guide Sleeve and Tappit Boot Kits To Fit All 5C1400 / 5C1405 Calipers

5R0400 - Tappet Kit 5R0200 - Full Kit 5RS200 - Single Sleeve



K013174

K132665X50

BPW 0536270361

LB195

5B1505

Brake Chamber Mounting Angle
+5°



Long Guide Sleeve



Chain Cover - Plain



K003784

K153781X50

BPW 0536270390

LB225

5C1405

Brake Chamber Mounting Angle
0°



Long Guide Sleeve



Chain Cover - Plain



5C4400

LC225

BPW 0536270621

K012634

K132663X50



Brake Chamber Mounting Angle



Long Guide Sleeve



Chain Cover - Plain



5C1400

LB225

DAF 1862301

K003803

K140741X50



Brake Chamber Mounting Angle



Long Guide Sleeve



Chain Cover - Plain



Tappit Boot & Chain Cover Kits For 5C4400/05

5R0300 - Chain Cover Kit 5R0400 - Tappet Kit



Guide Sleeve Kits To Fit All 5C4400 / 05 Calipers

5R0205 - Full Kit 5RS205 - Short Kit 5RL200 - Long Kit



Guide Sleeve Kits - Fully Sealed 5C1400 / 05

5R0215 - Full Kit 5RS215 - Single Sleeve



Guide Sleeve and Tappit Boot Kits To Fit All 5C1400 / 5C1405 Calipers

5R0400 - Tappet Kit 5R0200 - Full Kit 5RS200 - Single Sleeve



K012633

K132662X50

BPW 0536270631

LC225

5C4405

Brake Chamber Mounting Angle



Long Guide Sleeve



Chain Cover - Plain



K003804

K140740X50

DAF 1862300

LB225

5C1405

Brake Chamber Mounting Angle



Long Guide Sleeve



Chain Cover - Plain



5C1440

LB225

DAF 1658011

K003807

K140739X50



Brake Chamber Mounting Angle



Long Guide Sleeve



Chain Cover -
Clip and Screw



Sensor Type
On/Off



5B1400

LB195

Iveco 42558860

K003789

K163192X50



Brake Chamber Mounting Angle



Long Guide Sleeve



Chain Cover -
Plain



Guide Sleeve Kits - Fully Sealed 5C1440 / 05

5R0215 - Full Kit 5RS215 - Single Sleeve



Guide Sleeve and Tappit Boot Kits To Fit All 5C1440 / 5C1445 Calipers

5R0400 - Tappet Kit 5R0200 - Full Kit 5RS200 - Single Sleeve



Guide Sleeve Kits - Fully Sealed 5B1400 / 05

5R0215 - Full Kit 5RS215 - Single Sleeve



Guide Sleeve and Tappit Boot Kits To Fit All 5B1400 / 5B1405 Calipers

5R0400 - Tappet Kit 5R0200 - Full Kit 5RS200 - Single Sleeve



K003808

K140738X50

DAF 1658010

LB225

5C1445

Brake Chamber Mounting Angle



Long Guide Sleeve



Chain Cover -
Clip and Screw



Sensor Type
On/Off



K003790

K163193X50

Iveco 42558861

LB195

5B1405

Brake Chamber Mounting Angle



Long Guide Sleeve



Chain Cover -
Plain



5C1100

LB225

Iveco 42558857

K004578

K163187X50



Brake Chamber Mounting Angle



Long Guide Sleeve



Chain Cover - Plain



5C1120

LB225

Iveco 42558855

K013160

K163184X50



Brake Chamber Mounting Angle



Long Guide Sleeve



Chain Cover - Clip and Screw



Sensor Type Linear



Guide Sleeve Kits - Fully Sealed 5C1100 / 05

5R0215 - Full Kit 5RS215 - Single Sleeve



Guide Sleeve and Tappit Boot Kits To Fit All 5C1100 / 5C1105 Calipers

5R0400 - Tappet Kit 5R0200 - Full Kit 5RS200 - Single Sleeve



Guide Sleeve Kits - Fully Sealed 5C1120 / 05

5R0215 - Full Kit 5RS215 - Single Sleeve



Guide Sleeve and Tappit Boot Kits To Fit All 5C1120 / 5C1125 Calipers

5R0400 - Tappet Kit 5R0200 - Full Kit 5RS200 - Single Sleeve



K004579

K163186X50

Iveco 42558856

LB225

5C1105

Brake Chamber Mounting Angle



Long Guide Sleeve



Chain Cover - Plain



K013161

K163183X50

Iveco 42558854

LB225

5C1125

Brake Chamber Mounting Angle



Long Guide Sleeve



Chain Cover - Clip and Screw



Sensor Type Linear



5B1500

LB195

JOST JAE0250402701

K013173

K132664X50



Brake Chamber Mounting Angle
+5°



Long Guide Sleeve



Chain Cover - Plain



5C1100

LB225

JOST JAE0250408383

K003781

K153784X50



Brake Chamber Mounting Angle
-12°



Long Guide Sleeve



Chain Cover - Plain



Guide Sleeve Kits - Fully Sealed 5B1500 / 05

5R0215 - Full Kit 5RS215 - Single Sleeve



Guide Sleeve and Tappit Boot Kits To Fit All 5B1500 / 5B1505 Calipers

5R0400 - Tappet Kit 5R0200 - Full Kit 5RS200 - Single Sleeve



Guide Sleeve Kits - Fully Sealed 5C1100 / 05

5R0215 - Full Kit 5RS215 - Single Sleeve



Guide Sleeve and Tappit Boot Kits To Fit All 5C1100 / 5C1105 Calipers

5R0400 - Tappet Kit 5R0200 - Full Kit 5RS200 - Single Sleeve



K013174

K132665X50

JOST JAE0250402601

LB195

5B1505

Brake Chamber Mounting Angle
+5°



Long Guide Sleeve



Chain Cover - Plain



K003782

K153783X50

JOST JAE0250408483

LB225

5C1105

Brake Chamber Mounting Angle
-12°



Long Guide Sleeve



Chain Cover - Plain



5C4400

LC225

JOST JAE0250409183

K012634

K132663X50



Brake Chamber Mounting Angle



Long Guide Sleeve



Chain Cover - Plain



5B1530

LB195

MAN 81508046472

K009161



Brake Chamber Mounting Angle



Long Guide Sleeve



Chain Cover - Clip and Screw



Sensor Type Stepped



Tappit Boot & Chain Cover Kits For 5C4400/05

5R0300 - Chain Cover Kit 5R0400 - Tappet Kit



Guide Sleeve Kits To Fit All 5C4400 / 05 Calipers

5R0205 - Full Kit 5RS205 - Short Kit 5RL200 - Long Kit



Guide Sleeve Kits - Fully Sealed 5B1530 / 35

5R0215 - Full Kit 5RS215 - Single Sleeve



Guide Sleeve and Tappit Boot Kits To Fit All 5B1530 / 5B1535 Calipers

5R0400 - Tappet Kit 5R0200 - Full Kit 5RS200 - Single Sleeve



K012633

K132662X50

JOST JAE0250409283

LC225

5C4405

Brake Chamber Mounting Angle



Long Guide Sleeve



Chain Cover - Plain



K009162

MAN 81508046471

LB195

5B1535

Brake Chamber Mounting Angle



Long Guide Sleeve



Chain Cover - Clip and Screw



Sensor Type Stepped



5C1430

LB225

MAN 81508046474

K003811

K136361X50



Brake Chamber Mounting Angle



Long Guide Sleeve



Chain Cover -
Clip and Screw



Sensor Type
Stepped



5C1600

LB225

MAN 81508046516

K010626



Brake Chamber Mounting Angle



Long Guide Sleeve



Chain Cover -
Plain



Guide Sleeve Kits - Fully Sealed 5C1430 / 35

5R0215 - Full Kit 5RS215 - Single Sleeve



Guide Sleeve and Tappit Boot Kits To Fit All 5C1430 / 5C1435 Calipers

5R0400 - Tappet Kit 5R0200 - Full Kit 5RS200 - Single Sleeve



Guide Sleeve Kits - Fully Sealed 5C1600 / 05

5R0215 - Full Kit 5RS215 - Single Sleeve



Guide Sleeve and Tappit Boot Kits To Fit All 5C1600 / 5C1605 Calipers

5R0400 - Tappet Kit 5R0200 - Full Kit 5RS200 - Single Sleeve



K003812

K136360X50

MAN 81508046473

LB225

5C1435

Brake Chamber Mounting Angle



Long Guide Sleeve



Chain Cover -
Clip and Screw



Sensor Type
Stepped



K010627

MAN 81508046515

LB225

5C1605

Brake Chamber Mounting Angle



Long Guide Sleeve



Chain Cover -
Plain



5C1630

LB225

MAN 81508046512

K003815

K140245X50



Brake Chamber Mounting Angle
+8°



Long Guide Sleeve



Chain Cover -
Clip and Screw



Sensor Type
Stepped



5C6930

LNR225

MAN 81508046496

K014065

K147314X50



Brake Chamber Mounting Angle
+93°



Long Guide Sleeve



Sensor Cover -
Clip and Screw



Sensor Type
Stepped



Guide Sleeve Kits - Fully Sealed 5C1630 / 35

5R0215 - Full Kit

5RS215 - Single Sleeve



Guide Sleeve and Tappit Boot Kits To Fit All 5C1630 / 5C1635 Calipers

5R0400 - Tappet Kit

5R0200 - Full Kit

5RS200 - Single Sleeve



Guide Sleeve Kits - Fully Sealed 5C6930 / 35

5R0215 - Full Kit

5RS215 - Single Sleeve



Guide Sleeve and Tappit Boot Kits To Fit All 5C6930 / 5C6935 Calipers

9R0450 - Tappet Boot Kit

5R0200 - Full Kit

5RS200 - Single Sleeve



K003816

K140244X50

MAN 81508046511

LB225

5C1635

Brake Chamber Mounting Angle
+8°



Long Guide Sleeve



Chain Cover -
Clip and Screw



Sensor Type
Stepped



K014066

K147313X50

MAN 81508046495

LNR225

5C6935

Brake Chamber Mounting Angle
+93°



Long Guide Sleeve



Sensor Cover -
Clip and Screw



Sensor Type
Stepped



5B1510

LB195

Mercedes A0054201783

K013175

K140755X50



Brake Chamber Mounting Angle
+5°



Long Guide Sleeve



Chain Cover -
Clip and Screw



Sensor Type
On/Off



5B1520

LB195

Mercedes A0054201983

K013177

K140757X50



Brake Chamber Mounting Angle
+5°



Long Guide Sleeve



Chain Cover -
Clip and Screw



Sensor Type
Linear



Guide Sleeve Kits - Fully Sealed 5B1510 / 15

5R0215 - Full Kit

5RS215 - Single Sleeve



Guide Sleeve and Tappit Boot Kits To Fit All 5B1510 / 5B1515 Calipers

5R0400 - Tappet Kit

5R0200 - Full Kit

5RS200 - Single Sleeve



Guide Sleeve Kits - Fully Sealed 5B1520 / 25

5R0215 - Full Kit

5RS215 - Single Sleeve



Guide Sleeve and Tappit Boot Kits To Fit All 5B1520 / 5B1525 Calipers

5R0400 - Tappet Kit

5R0200 - Full Kit

5RS200 - Single Sleeve



K013176

K140754X50

Mercedes A0054201883

LB195

5B1515

Brake Chamber Mounting Angle
+5°



Long Guide Sleeve



Chain Cover -
Clip and Screw



Sensor Type
On/Off



K013178

K140756X50

Mercedes A0054202083

LB195

5B1525

Brake Chamber Mounting Angle
+5°



Long Guide Sleeve



Chain Cover -
Clip and Screw



Sensor Type
Linear



5C1110

LB225

Mercedes A0044209683

K003797



Brake Chamber Mounting Angle



Long Guide Sleeve



Chain Cover -
Clip and Screw



Sensor Type
On/Off



5C1120

LB225

Mercedes A0044208883

K003799

K136363X50



Brake Chamber Mounting Angle



Long Guide Sleeve



Chain Cover -
Clip and Screw



Sensor Type
Linear



Guide Sleeve Kits - Fully Sealed 5C1110 / 15

5R0215 - Full Kit 5RS215 - Single Sleeve



Guide Sleeve and Tappit Boot Kits To Fit All 5C1110 / 5C1115 Calipers

5R0400 - Tappit Kit 5R0200 - Full Kit 5RS200 - Single Sleeve



Guide Sleeve Kits - Fully Sealed 5C1120 / 05

5R0215 - Full Kit 5RS215 - Single Sleeve



Guide Sleeve and Tappit Boot Kits To Fit All 5C1120 / 5C1125 Calipers

5R0400 - Tappit Kit 5R0200 - Full Kit 5RS200 - Single Sleeve



K003798

Mercedes A0044209583

LB225

5C1115

Brake Chamber Mounting Angle



Long Guide Sleeve



Chain Cover -
Clip and Screw



Sensor Type
On/Off



K003800

K136362X50

Mercedes A0044208783

LB225

5C1125

Brake Chamber Mounting Angle



Long Guide Sleeve



Chain Cover -
Clip and Screw



Sensor Type
Linear



5C1620

LB225

Mercedes A0044209083

K026763

K14985X50



Brake Chamber Mounting Angle

+8°



Long Guide Sleeve



Chain Cover -
Clip and Screw



Sensor Type
Linear



5C2110

LV225

Mercedes A0044207483

K052393K50



Brake Chamber Mounting Angle

-12°



Long Guide Sleeve



Chain Cover -
Clip and Screw



Sensor Type
On/Off



Guide Sleeve Kits - Fully Sealed 5C1620 / 25

5R0215 - Full Kit

5RS215 - Single Sleeve



Guide Sleeve and Tappit Boot Kits To Fit All 5C1620 / 5C1625 Calipers

5R0400 - Tappit Kit

5R0200 - Full Kit

5RS200 - Single Sleeve



Guide Sleeve Kits - Fully Sealed 5C2110 / 15

5R0215 - Full Kit

5RS215 - Single Sleeve



Guide Sleeve and Tappit Boot Kits To Fit All 5C2110 / 5C2115 Calipers

5R0405 - Tappit Kit

5R0200 - Full Kit

5RS200 - Single Sleeve



K026764

K149854X50

Mercedes A0044208983

LB225

5C1625

Brake Chamber Mounting Angle

+8°



Long Guide Sleeve



Chain Cover -
Clip and Screw



Sensor Type
Linear



K052392K50

Mercedes A0044207383

LV225

5C2115

Brake Chamber Mounting Angle

-12°



Long Guide Sleeve



Chain Cover -
Clip and Screw



Sensor Type
On/Off



5C2120

LV225

Mercedes A0044207283

K052391K50



Brake Chamber Mounting Angle



Long Guide Sleeve



Chain Cover - Clip and Screw



Sensor Type Linear



5C3110

LA225

Mercedes A0044207883

K052383K50



Brake Chamber Mounting Angle



Long Guide Sleeve



Chain Cover - Clip and Screw



Sensor Type On/Off



Guide Sleeve Kits - Fully Sealed 5C2120 / 25

5R0215 - Full Kit

5RS215 - Single Sleeve



Guide Sleeve and Tappit Boot Kits To Fit All 5C2120 / 5C2125 Calipers

5R0405 - Tappet Kit

5R0200 - Full Kit

5RS200 - Single Sleeve



Guide Sleeve Kits - Fully Sealed 5C3110 / 15

5R0215 - Full Kit

5RS215 - Single Sleeve



Guide Sleeve and Tappit Boot Kits To Fit All 5C3110 / 5C3115 Calipers

5R0405 - Tappet Kit

5R0200 - Full Kit

5RS200 - Single Sleeve



K052390K50

Mercedes A0044207183

LV225

5C2125

Brake Chamber Mounting Angle



Long Guide Sleeve



Chain Cover - Clip and Screw



Sensor Type Linear



K052382K50

Mercedes A0044207783

LA225

5C3115

Brake Chamber Mounting Angle



Long Guide Sleeve



Chain Cover - Clip and Screw



Sensor Type On/Off



5C3120

LA225

Mercedes A0044207683

K052381K50



Brake Chamber Mounting Angle



Long Guide Sleeve



Chain Cover -
Clip and Screw



Sensor Type
Linear



5C6920

LNR225

Mercedes A0024205283

K002964

K147312X50



Brake Chamber Mounting Angle



Long Guide Sleeve



Sensor Cover -
Clip and Screw



Sensor Type
Linear



Guide Sleeve Kits - Fully Sealed 5C3120 / 25

5R0215 - Full Kit

5RS215 - Single Sleeve



Guide Sleeve and Tappit Boot Kits To Fit All 5C3120 / 5C3125 Calipers

5R0405 - Tappit Kit

5R0200 - Full Kit

5RS200 - Single Sleeve



Guide Sleeve Kits - Fully Sealed 5C6920 / 25

5R0215 - Full Kit

5RS215 - Single Sleeve



Guide Sleeve and Tappit Boot Kits To Fit All 5C6920 / 5C6925 Calipers

9R0450 - Tappit Boot Kit

5R0200 - Full Kit

5RS200 - Single Sleeve



K052380K50

Mercedes A0044207583

LA225

5C3125

Brake Chamber Mounting Angle



Long Guide Sleeve



Chain Cover -
Clip and Screw



Sensor Type
Linear



K002965

K147311X50

Mercedes A0024205183

LNR225

5C6925

Brake Chamber Mounting Angle



Long Guide Sleeve



Sensor Cover -
Clip and Screw



Sensor Type
Linear



9B2100-71 NV195

Renault 7420566793

LRG740

MXC9307023



Brake Chamber Mounting Angle



Long Guide Sleeve



Guide Sleeve Centre Distance - 264 mm



9C2100-73 NV225

Renault 7420566588

LRG738

MXC9309040



Brake Chamber Mounting Angle



Long Guide Sleeve



Guide Sleeve Centre Distance - 264 mm



Carrier for 9B2100-71 / 9B2105-71

9T7071 - Carrier Kit

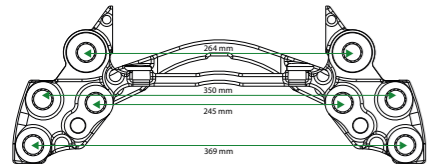

Guide Sleeve and Tappit Boot Kits for 9B2100-71 / 9B2105-71

9R0250 - Guide Sleeve Kit

9R0450 - Tappet Boot Kit



Carrier for 9C2100-73 / 9C2105-73

9T7073 - Carrier Kit

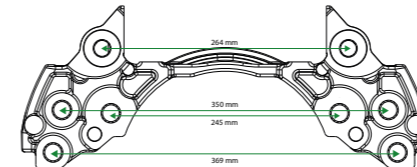

Guide Sleeve and Tappit Boot Kits for 9C2100-73 / 9C2105-73

9R0250 - Guide Sleeve Kit

9R0450 - Tappet Boot Kit



LRG741 MXC9307024

Renault 7420566794

NV195 9B2105-71

Brake Chamber Mounting Angle

0°



Long Guide Sleeve



Guide Sleeve Centre Distance - 264 mm



LRG739 MXC9309041

Renault 7420566589

NV225 9C2105-73

Brake Chamber Mounting Angle

0°



Long Guide Sleeve



Guide Sleeve Centre Distance - 264 mm



9C3100-74 NT225

Renault 7420566578

LRG736

MXC9309038



Brake Chamber Mounting Angle



Long Guide Sleeve



Guide Sleeve Centre Distance - 264 mm



9C4200-74 NR225

Renault 7420566580

LRG734

MXC9309036



Brake Chamber Mounting Angle



Fixed Guide Sleeve



Guide Sleeve Centre Distance - 305 mm



Carrier for 9C3100-74 / 9C3105-74

9T7074 - Carrier Kit

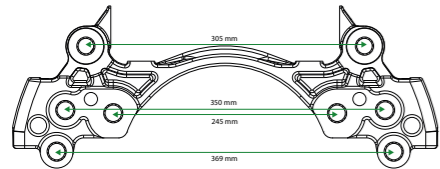

Guide Sleeve and Tappit Boot Kits for 9C3100-74 / 9C3105-74

9R0250 - Guide Sleeve Kit

9R0450 - Tappet Boot Kit



Carrier for 9C4200-74 / 9C4205-74

9T7074 - Carrier Kit

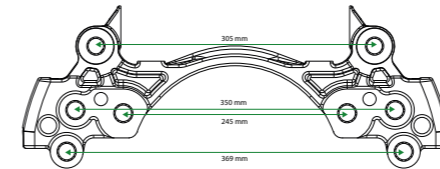

Guide Sleeve and Tappit Boot Kits for 9C4200-74 / 9C4205-74

9R0255 - Guide Sleeve Kit

9R0450 - Tappet Boot Kit



LRG737 MXC9309039

Renault 7420566579

NT225 9C3105-74

Brake Chamber Mounting Angle



Long Guide Sleeve



Guide Sleeve Centre Distance - 264 mm



LRG735 MXC9309037

Renault 7420566581

NR225 9C4205-74

Brake Chamber Mounting Angle



Fixed Guide Sleeve



Guide Sleeve Centre Distance - 305 mm



9B1100-70 NX195

ROR 68033360

LRG703

MXC9307006



Brake Chamber Mounting Angle



Long Guide Sleeve



Guide Sleeve Centre Distance - 264 mm



9C1100-72 NX225

ROR 68033981

LRG764

MXC9309044



Brake Chamber Mounting Angle



Long Guide Sleeve



Guide Sleeve Centre Distance - 264 mm



Carrier for 9B1100-70 / 9B1105-70

9T7070 - Carrier Kit

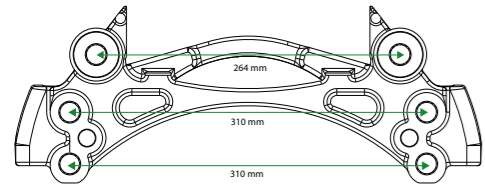

Guide Sleeve and Tappit Boot Kits for 9B1100-70 / 9B1105-70

9R0250 - Guide Sleeve Kit

9R0450 - Tappet Boot Kit



Carrier for 9C1100-72 / 9C1105-72

9T7072 - Carrier Kit

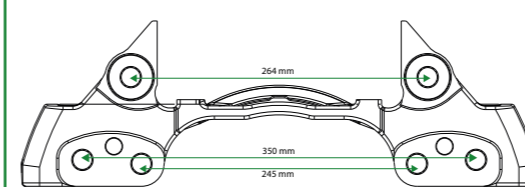

Guide Sleeve and Tappit Boot Kits for 9C1100-72 / 9C1105-72

9R0250 - Guide Sleeve Kit

9R0450 - Tappet Boot Kit



LRG702 MXC9307005

ROR 68033359

NX195 **9B1105-70**

Brake Chamber Mounting Angle



Long Guide Sleeve



Guide Sleeve Centre Distance - 264 mm



LRG765 MXC9309045

ROR 68033982

NX225 **9C1105-72**

Brake Chamber Mounting Angle



Long Guide Sleeve



Guide Sleeve Centre Distance - 264 mm



5B1500

LB195

SAE-SMB 9285165

K013173

K132664X50



Brake Chamber Mounting Angle

+5°



Long Guide Sleeve



Chain Cover - Plain



5C1400

LB225

SAE-SMB 9285159

K003783

K153782X50



Brake Chamber Mounting Angle

0°



Long Guide Sleeve



Chain Cover - Plain



Guide Sleeve Kits - Fully Sealed 5B1500 / 05

5R0215 - Full Kit

5RS215 - Single Sleeve



Guide Sleeve and Tappit Boot Kits To Fit All 5B1500 / 5B1505 Calipers

5R0400 - Tappet Kit

5R0200 - Full Kit

5RS200 - Single Sleeve



Guide Sleeve Kits - Fully Sealed 5C1400 / 05

5R0215 - Full Kit

5RS215 - Single Sleeve



Guide Sleeve and Tappit Boot Kits To Fit All 5C1400 / 5C1405 Calipers

5R0400 - Tappet Kit

5R0200 - Full Kit

5RS200 - Single Sleeve



K013174

K132665X50

SAE-SMB 9285166

LB195

5B1505

Brake Chamber Mounting Angle

+5°



Long Guide Sleeve



Chain Cover - Plain



K003784

K153781X50

SAE-SMB 9285160

LB225

5C1405

Brake Chamber Mounting Angle

0°



Long Guide Sleeve



Chain Cover - Plain



5B1500

LB195

SAF 3080002401

K013173

K132664X50



Brake Chamber Mounting Angle
+5°



Long Guide Sleeve



Chain Cover - Plain



5C1100

LB225

SAF 3080002601

K003781

K153784X50



Brake Chamber Mounting Angle
-12°



Long Guide Sleeve



Chain Cover - Plain



Guide Sleeve Kits - Fully Sealed 5B1500 / 05

5R0215 - Full Kit 5RS215 - Single Sleeve



Guide Sleeve and Tappit Boot Kits To Fit All 5B1500 / 5B1505 Calipers

5R0400 - Tappet Kit 5R0200 - Full Kit 5RS200 - Single Sleeve



Guide Sleeve Kits - Fully Sealed 5C1100 / 05

5R0215 - Full Kit 5RS215 - Single Sleeve



Guide Sleeve and Tappit Boot Kits To Fit All 5C1100 / 5C1105 Calipers

5R0400 - Tappet Kit 5R0200 - Full Kit 5RS200 - Single Sleeve



K013174

K132665X50

SAF 3080002501

LB195

5B1505

Brake Chamber Mounting Angle
+5°



Long Guide Sleeve



Chain Cover - Plain



K003782

K153783X50

SAF 3080002701

LB225

5C1105

Brake Chamber Mounting Angle
-12°



Long Guide Sleeve



Chain Cover - Plain



5C1400

LB225

SAF 3080003101

K003783

K153782X50



Brake Chamber Mounting Angle



Long Guide Sleeve



Chain Cover - Plain



5C4400

LC225

SAF 3080006001

K012634

K132663X50



Brake Chamber Mounting Angle



Long Guide Sleeve



Chain Cover - Plain



Guide Sleeve Kits - Fully Sealed 5C1400 / 05

5R0215 - Full Kit

5RS215 - Single Sleeve



Guide Sleeve and Tappit Boot Kits To Fit All 5C1400 / 5C1405 Calipers

5R0400 - Tappit Kit

5R0200 - Full Kit

5RS200 - Single Sleeve



Tappit Boot & Chain Cover Kits For 5C4400/05

5R0300 - Chain Cover Kit

5R0400 - Tappit Kit



Guide Sleeve Kits To Fit All 5C4400 / 05 Calipers

5R0205 - Full Kit

5RS205 - Short Kit

5RL200 - Long Kit



K003784

K153781X50

SAF 3080003001

LB225

5C1405

Brake Chamber Mounting Angle



Long Guide Sleeve



Chain Cover - Plain



K012633

K132662X50

SAF 3080005901

LC225

5C4405

Brake Chamber Mounting Angle



Long Guide Sleeve



Chain Cover - Plain



5C1400

LB225

Scania 1928819

K041389K50

K149859X50



Brake Chamber Mounting Angle



Long Guide Sleeve



Chain Cover - Plain



5C1450

LB225

Scania 1928820

K040953K50

K149857X50



Brake Chamber Mounting Angle



Long Guide Sleeve



Chain Cover - Clip and Screw



Sensor Type Linear



Guide Sleeve Kits - Fully Sealed 5C1400 / 05

5R0215 - Full Kit

5RS215 - Single Sleeve



Guide Sleeve and Tappit Boot Kits To Fit All 5C1400 / 5C1405 Calipers

5R0400 - Tappit Kit

5R0200 - Full Kit

5RS200 - Single Sleeve



Guide Sleeve Kits - Fully Sealed 5C1450 / 55

5R0215 - Full Kit

5RS215 - Single Sleeve



Guide Sleeve and Tappit Boot Kits To Fit All 5C1450 / 5C1455 Calipers

5R0400 - Tappit Kit

5R0200 - Full Kit

5RS200 - Single Sleeve



K041390K50 K149858X50

Scania 1928818

LB225

5C1405

Brake Chamber Mounting Angle



Long Guide Sleeve



Chain Cover - Plain



K040954K50 K149856X50

Scania 1998821

LB225

5C1455

Brake Chamber Mounting Angle



Long Guide Sleeve



Chain Cover - Clip and Screw



Sensor Type Linear



5C6800

LNR225

Scania 1921153

K002966



Brake Chamber Mounting Angle
+86°



Long Guide Sleeve



Sensor Cover -
N/A

5C6820

LNR225

Scania 1921151

K003192

K040945K50



Brake Chamber Mounting Angle
+86°



Long Guide Sleeve



Sensor Cover -
Clip and Screw



Sensor Type
Linear



Guide Sleeve Kits - Fully Sealed 5C6800 / 05

5R0215 - Full Kit

5RS215 - Single Sleeve



Guide Sleeve and Tappit Boot Kits To Fit All 5C6800 / 5C6805 Calipers

9R0450 - Tappit Boot Kit

5R0200 - Full Kit

5RS200 - Single Sleeve



Guide Sleeve Kits - Fully Sealed 5C6820 / 25

5R0215 - Full Kit

5RS215 - Single Sleeve



Guide Sleeve and Tappit Boot Kits To Fit All 5C6820 / 5C6825 Calipers

9R0450 - Tappit Boot Kit

5R0200 - Full Kit

5RS200 - Single Sleeve



K002967

Scania 1921152

LNR225

5C6805

Brake Chamber Mounting Angle
+86°



Long Guide Sleeve



Sensor Cover -
N/A



K003193

K040946K50

Scania 1921150

LNR225

5C6825

Brake Chamber Mounting Angle
+86°



Long Guide Sleeve



Sensor Cover -
Clip and Screw



Sensor Type
Linear



5C6900 LNR225 Scania 1757011 K002962 K147310X50



Brake Chamber Mounting Angle
+93°



Long Guide Sleeve



Sensor Cover - N/A

5C6920 LNR225 Scania 2395648 K040943K50 K147316X50



Brake Chamber Mounting Angle
+93°



Long Guide Sleeve



Sensor Cover - Clip and Screw



Sensor Type Linear



Guide Sleeve Kits - Fully Sealed 5C6900 / 05

5R0215 - Full Kit 5RS215 - Single Sleeve



Guide Sleeve and Tappit Boot Kits To Fit All 5C6900 / 5C6905 Calipers

9R0450 - Tappit Boot Kit 5R0200 - Full Kit 5RS200 - Single Sleeve



Guide Sleeve Kits - Fully Sealed 5C6920 / 25

5R0215 - Full Kit 5RS215 - Single Sleeve



Guide Sleeve and Tappit Boot Kits To Fit All 5C6920 / 5C6925 Calipers

9R0450 - Tappit Boot Kit 5R0200 - Full Kit 5RS200 - Single Sleeve



K002963 K147309X50 Scania 1757010 LNR225 **5C6905**



Brake Chamber Mounting Angle
+93°



Long Guide Sleeve



Sensor Cover - N/A

K040944K50 K147315X50 Scania 2395647 LNR225 **5C6925**



Brake Chamber Mounting Angle
+93°



Long Guide Sleeve



Sensor Cover - Clip and Screw



Sensor Type Linear



5B1500

LB195

Schmitz 17257

K013173

K132664X50



Brake Chamber Mounting Angle



Long Guide Sleeve



Chain Cover - Plain



5C1100

LB225

Schmitz 17646

K003781

K153784X50



Brake Chamber Mounting Angle



Long Guide Sleeve



Chain Cover - Plain



Guide Sleeve Kits - Fully Sealed 5B1500 / 05

5R0215 - Full Kit 5RS215 - Single Sleeve



Guide Sleeve and Tappit Boot Kits To Fit All 5B1500 / 5B1505 Calipers

5R0400 - Tappit Kit 5R0200 - Full Kit 5RS200 - Single Sleeve



Guide Sleeve Kits - Fully Sealed 5C1100 / 05

5R0215 - Full Kit 5RS215 - Single Sleeve



Guide Sleeve and Tappit Boot Kits To Fit All 5C1100 / 5C1105 Calipers

5R0400 - Tappit Kit 5R0200 - Full Kit 5RS200 - Single Sleeve



K013174

K132665X50

Schmitz 17258

LB195

5B1505

Brake Chamber Mounting Angle



Long Guide Sleeve



Chain Cover - Plain



K003782

K153783X50

Schmitz 17645

LB225

5C1105

Brake Chamber Mounting Angle



Long Guide Sleeve



Chain Cover - Plain



5C4400

LC225

Schmitz 56794

K012634

K132663X50



Brake Chamber Mounting Angle



Long Guide Sleeve



Chain Cover - Plain



9B2100-71

NV195

VOLVO 20498846

LRG732

MXC9307023



Brake Chamber Mounting Angle



Long Guide Sleeve



Guide Sleeve Centre Distance - 264 mm



Tappit Boot & Chain Cover Kits For 5C4400/05

5R0300 - Chain Cover Kit 5R0400 - Tappet Kit



Guide Sleeve Kits To Fit All 5C4400 / 05 Calipers

5R0205 - Full Kit 5R5205 - Short Kit 5RL200 - Long Kit



Carrier for 9B2100-71 / 9B2105-71

9T7071 - Carrier Kit

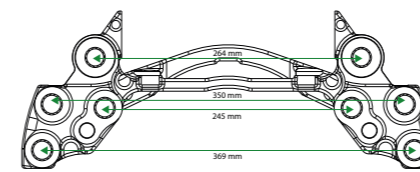

Guide Sleeve and Tappit Boot Kits for 9B2100-71 / 9B2105-71

9R0250 - Guide Sleeve Kit 9R0450 - Tappet Boot Kit



K012633

K132662X50

Schmitz 56793

LC225

5C4405

Brake Chamber Mounting Angle



Long Guide Sleeve



Chain Cover - Plain



LRG733

MXC9307024

VOLVO 20498847

NV195 9B2105-71

Brake Chamber Mounting Angle



Long Guide Sleeve



Guide Sleeve Centre Distance - 264 mm



9C2100-73 NV225

VOLVO 20527038

LRG730

MXC9309034



Brake Chamber Mounting Angle



Long Guide Sleeve



Guide Sleeve Centre Distance - 264 mm



9C3100-74 NT225

VOLVO 20526990

LRG728

MXC9309032



Brake Chamber Mounting Angle



Long Guide Sleeve



Guide Sleeve Centre Distance - 264 mm



Carrier for 9C2100-73 / 9C2105-73

9T7073 - Carrier Kit

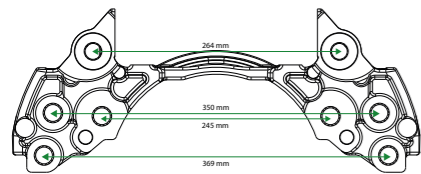

Guide Sleeve and Tappit Boot Kits for 9C2100-73 / 9C2105-73

9R0250 - Guide Sleeve Kit

9R0450 - Tappet Boot Kit



Carrier for 9C3100-74 / 9C3105-74

9T7074 - Carrier Kit

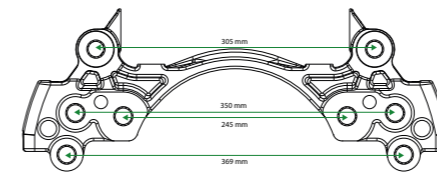

Guide Sleeve and Tappit Boot Kits for 9C3100-74 / 9C3105-74

9R0250 - Guide Sleeve Kit

9R0450 - Tappet Boot Kit



LRG731 MXC9309035

VOLVO 20527039

NV225 9C2105-73

Brake Chamber Mounting Angle



Long Guide Sleeve



Guide Sleeve Centre Distance - 264 mm



LRG729 MXC9309033

VOLVO 20526991

NT225 9C3105-74

Brake Chamber Mounting Angle



Long Guide Sleeve



Guide Sleeve Centre Distance - 264 mm



9C4200-74 NR225

VOLVO 20527036

LRG726 MXC9309030



Brake Chamber Mounting Angle
+81°



Fixed Guide Sleeve



Guide Sleeve Centre Distance -
305 mm



5C6900 LNR225

ZF 501007176

K002962 K147310X50



Brake Chamber Mounting Angle
+93°



Long Guide Sleeve



Sensor Cover -
N/A

Carrier for 9C4200-74 / 9C4205-74

9T7074 - Carrier Kit

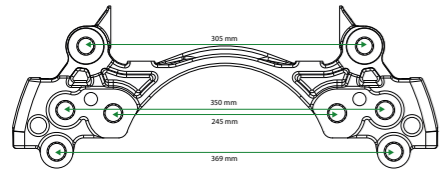

Guide Sleeve and Tappit Boot Kits for 9C4200-74 / 9C4205-74

9R0255 - Guide Sleeve Kit

9R0450 - Tappit Boot Kit



Guide Sleeve Kits - Fully Sealed 5C6900 / 05

5R0215 - Full Kit

5RS215 - Single Sleeve



Guide Sleeve and Tappit Boot Kits To Fit All 5C6900 / 5C6905 Calipers

9R0450 - Tappit Boot Kit

5R0200 - Full Kit

5RS200 - Single Sleeve



LRG727 MXC9309031

VOLVO 20527037

NR225 9C4205-74

Brake Chamber Mounting Angle
+81°



Fixed Guide Sleeve



Guide Sleeve Centre Distance -
305 mm



K002963 K147309X50

ZF 501007175

LNR225 5C6905

Brake Chamber Mounting Angle
+93°



Long Guide Sleeve



Sensor Cover -
N/A



5C6920

LNR225

ZF 501007173

K002964

K147312X50



Brake Chamber Mounting Angle

+93°



Long Guide Sleeve



Sensor Cover -
Clip and Screw



Sensor Type
Linear



Guide Sleeve Kits - Fully Sealed 5C6920 / 25

5R0215 - Full Kit

5RS215 - Single Sleeve



Guide Sleeve and Tappit Boot Kits To Fit All 5C6920 / 5C6925 Calipers

9R0450 - Tappit Boot Kit

5R0200 - Full Kit

5RS200 - Single Sleeve



K002965

K147311X50

ZF 501007172

LNR225

5C6925

Brake Chamber Mounting Angle

+93°



Long Guide Sleeve



Sensor Cover -
Clip and Screw



Sensor Type
Linear



Guide Sleeve Kits - Fully Sealed Calipers

5R0215 - Full Kit 5RS215 - Single Sleeve



Guide Sleeve Kits



Tappet Boot Kits



Chain Cover Kits



Sensor Kits



Other Kits



	Guide Sleeve Kits								Tappet Boot Kits			Chain Cover Kits				Sensor Kits		
	5R0200	5RS200	5RL200	5R0205	5RS205	5R0215	5RS215	9R0250	9R0255	5R0400	5R0405	9R0450	5R0300	5R0330	5R0335	5R0340	5R0370	5R0375
5B1400	X	X	X			X	X			X			X					
5B1405	X	X	X			X	X			X			X					
5B1500	X	X	X			X	X			X			X					
5B1505	X	X	X			X	X			X			X					
5B1510	X	X	X			X	X			X				X				
5B1515	X	X	X			X	X			X				X				
5B1520	X	X	X			X	X			X					X			
5B1525	X	X	X			X	X			X					X			
5B1530	X	X	X			X	X			X						X		
5B1535	X	X	X			X	X			X						X		
5C1100	X	X	X			X	X			X			X					
5C1105	X	X	X			X	X			X			X					
5C1110	X	X	X			X	X			X				X				
5C1115	X	X	X			X	X			X				X				
5C1120	X	X	X			X	X			X					X			
5C1125	X	X	X			X	X			X					X			
5C1400	X	X	X			X	X			X			X					
5C1405	X	X	X			X	X			X			X					
5C1430	X	X	X			X	X			X						X		
5C1435	X	X	X			X	X			X						X		
5C1440	X	X	X			X	X			X								
5C1445	X	X	X			X	X			X				X				
5C1450	X	X	X			X	X			X					X			
5C1455	X	X	X			X	X			X					X			
5C1600	X	X	X			X	X			X			X					
5C1605	X	X	X			X	X			X			X					
5C1620	X	X	X			X	X			X					X			
5C1625	X	X	X			X	X			X					X			
5C1630	X	X	X			X	X			X						X		
5C1635	X	X	X			X	X			X						X		
5C4400			X	X	X					X			X					
5C4405			X	X	X					X			X					
5C2110	X	X	X			X	X				X			X				
5C2115	X	X	X			X	X				X			X				
5C2120	X	X	X			X	X				X				X			
5C2125	X	X	X			X	X				X				X			
5C3110	X	X	X			X	X				X			X				
5C3115	X	X	X			X	X				X			X				
5C3120	X	X	X			X	X				X				X			
5C3125	X	X	X			X	X				X				X			
5C6800	X	X	X			X	X					X						
5C6805	X	X	X			X	X					X						
5C6820	X	X	X			X	X					X					X	
5C6825	X	X	X			X	X					X					X	
5C6900	X	X	X			X	X					X						
5C6905	X	X	X			X	X					X						
5C6920	X	X	X			X	X					X					X	
5C6925	X	X	X			X	X					X					X	
5C6930	X	X	X			X	X					X						X
5C6935	X	X	X			X	X					X						X
9B1100-70								X					X					
9B1105-70								X					X					
9B2100-71								X					X					
9B2105-71								X					X					
9C1100-72								X					X					
9C1105-72								X					X					
9C2100-73								X					X					
9C2105-73								X					X					
9C3100-74								X					X					
9C3105-74								X					X					
9C4200-74									X				X					
9C4205-74									X				X					

LC225 Trailer Caliper

Other Assemblies Available on Request

5C4400 LH



5C4405 RH



5C440010 LH SAF
5C440005 LH SAE-SMB

5C440510 RH SAF
5C440505 RH SAE-SMB



5T1010 Carrier SAF

5T1005 Carrier SAE-SMB



5R0205
Guide Sleeve Kit

5R0300
Chain Cover Kit

5R0400
Tappet Boot Kit

5RS205
Short Sleeve Kit

5RL200
Long Sleeve Kit



5T1001 Fits: LB225

Replaces: K001278



Pad Size:
W 248mm
H 110mm
1 = 286mm
2 = 408mm M18 x 1.5
3 = 380mm M18 x 1.5
4 = 220mm M18 x 1.5

All dimensions are measured from hole centre to hole centre

5T1007 Fits: LB225

Replaces: K001507, K001520



Pad Size:
W 248mm
H 110 mm
1 = 286mm
2 = 400mm M20 x 2.5
3 = 378mm M20 x 2.5
4 = 290mm M20 x 2.5

All dimensions are measured from hole centre to hole centre

5T1002 Fits: LB225

Replaces: K001529, K001530



Pad Size:
W 248mm
H 110mm
1 = 286mm
2 = 408mm M16 x 1.5
3 = 378mm M16 x 1.5
4 = 290mm M16 x 1.5

All dimensions are measured from hole centre to hole centre

5T1008 Fits: LB225

Replaces: K017864



Pad Size:
W 248mm
H 110 mm
1 = 286mm
2 = 400mm M20 x 1.5
3 = 378mm M20 x 1.5
4 = 290mm M20 x 1.5

All dimensions are measured from hole centre to hole centre

5T1005 Fits: LC225

Replaces: K004099



Pad Size:
W 210mm
H 108mm
1 = 266mm
2 = 400mm M16 x 1.5
3 = 378mm M16 x 1.5
4 = 210mm M16 x 1.5

All dimensions are measured from hole centre to hole centre

5T1010 Fits: LC225

Replaces: K015308



Pad Size:
W 210mm
H 108mm
1 = 266mm
2 = 316mm M18 x 1.5
3 = 216mm M18 x 1.5

All dimensions are measured from hole centre to hole centre

5T1006 Fits: LB225

Replaces: K000026



Pad Size:
W 248mm
H 110mm
1 = 286mm
2 = 400mm M16 x 1.5
3 = 378mm M16 x 1.5
4 = 210mm M16 x 1.5

All dimensions are measured from hole centre to hole centre

5T1011 Fits: LB225

Replaces: K011479



Pad Size:
W 248mm
H 110 mm
1 = 286mm
2 = 400mm M18 x 1.5
3 = 378mm M18 x 1.5
4 = 290mm M18 x 1.5

All dimensions are measured from hole centre to hole centre